

# ZILFOR

PRECISION FURNITURE



AMICO BOX

# AMICO BOX

## PROSTHESIS FINISHING UNIT

Amico Box is a portable mini-lab characterized by an harmonious and ergonomic design and it's the ideal workstation for its flexible employment that guarantees excellent lighting and cleaning conditions and it's easy to move from one room to another for retouches directly at the chair. Amico Box is equipped with a single shaft brush with high functionality, an high polisher performance, a silent suction system with high functionality, a lamp with high colour rendering, a master switch and also switches for all devices, a polycarbonate protection with a central plexiglas plate to protect the working area, synthetic fibres filter bags for raising dust and the lodging for any brand of rheostat and micromotor.



## MACCHINA PER LA FINITURA DI STRUTTURE PROTESICHE

L'unità di lavoro Amico Box è il mini-laboratorio portatile dalla linea armoniosa ed ergonomica, dal design ricercato e funzionale. Ideale postazione di lavoro, su base auto frenante, garantisce ottime condizioni di illuminazione e di pulizia e si sposta facilmente da un'unità operativa all'altra per consentire i ritocchi direttamente alla poltrona. Amico Box è corredato di pulitrice monoalbero, impianto silenzioso di aspirazione ad alta efficienza, lampada ad alta resa cromatica, interruttore generale e interruttori di accensione dei singoli apparecchi, protezione in polycarbonato con finestra centrale in plexiglas a protezione contro schizzi e schegge, sacchetto filtro in fibre sintetiche per il recupero delle polveri di lavoro e di un alloggiamento per qualsiasi marca di reostato e micromotore.



## APPAREIL POUR LES RETOUCHES DE PROTHESES AU CABINET DENTAIRE

L'Amico Box est un mini-laboratoire mobile qui se caractérise par un design agréable et une conception ergonomique et par une grande souplesse d'emploi. C'est une station de travail idéale qui garantit d'excellentes conditions d'éclairage et des retouches dans une propreté absolue; il se déplace aisément d'un cabinet à l'autre pour être utilisé près du fauteuil. L'Amico Box est équipé en série d'une polisseuse mono-arbre, d'une aspiration puissante et silencieuse, d'une lampe à haut rendement chromatique, d'un interrupteur général, d'un interrupteur pour l'allumage indépendant de chaque appareil. Pourvu d'un capot de protection en polycarbonate avec une fenêtre centrale en plexiglas, pour une protection anti projection. Un filtre de récupération des poussières, en fibres synthétiques est positionné à l'arrière. Le socle repose pied est auto freinant. Le positionnement du moteur et du rhéostat de toute marques est très facile grâce à une pris électrique prévu pour le branchement.

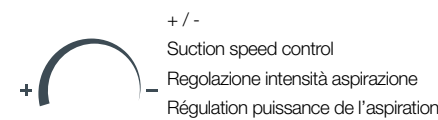
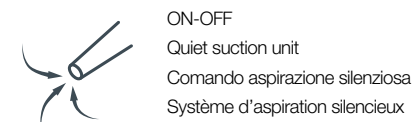
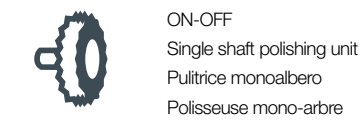
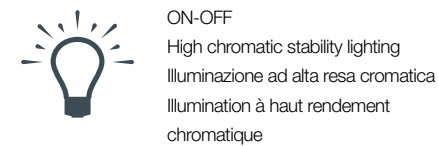
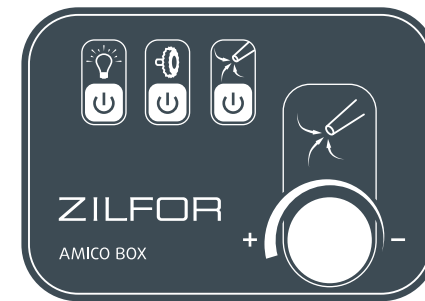

Motor protection filter  
Filtro protezione motore  
Filtre de protection du moteur



Electronic card  
Scheda elettronica  
Fiche électronique



Filter bag  
Sacchetto filtro  
Sachet filtre



Brush  
Spazzola  
Pousseuse











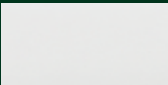
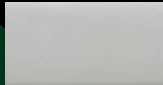

Amico Box is also available in a fixed version in which the operation unit is directly placed on the work top and it is predisposed for suction unit.

Amico Box è anche disponibile nella "versione d'appoggio", nella quale l'unità operativa anziché essere su ruote, è direttamente posta sul banco di lavoro ed è predisposta per l'aspirazione

L'Amico Box est aussi disponible dans une version pour plan de travail avec des aménagements à prévoir..(Moteur aspiration – prise de courants etc...)

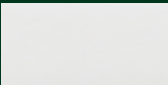
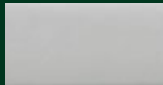
## COLOUR CHOICES / OPZIONI COLORE / OPTIONS DE COULEUR

Cover Coperchio Couvercle				
	Green / Verde / Vert	Blue / Blu / Bleu	White / Bianco / Blanc	Grey / Grigio / Gris
Front drawer for small drawer dust raising Frontalino per cassetto recupero polveri Façade pour petit tiroir de récupération des poussières				
	Green / Verde / Vert	Blue / Blu / Bleu	White / Bianco / Blanc	Grey / Grigio / Gris
Tray Vassoio Plateau				
	Green / Verde / Vert	Blue / Blu / Bleu	White / Bianco / Blanc	Grey / Grigio / Gris
Covering for platform Rivestimento pedana Revêtement pour le socle				
		Blue / Blu / Bleu		Grey / Grigio / Gris

## TECHNICAL FEATURES / CARATTERISTICHE TECNICHE / CARACTÉRISTIQUES TECHNIQUES

Size / Dimensioni / Dimensions:

L 500 x D 480 x H 1120 mm

Packing Size / Dimensioni imballo

Dimensions de l'emballage: L 1200 x D 600 x H 650 mm

Weight / Peso / Poids: kg. 50 - kg. 60

Voltage / Tensione / Tension: 230V/50Hz

Total Power Supply / Potenza totale / Puissance totale: 1470 W

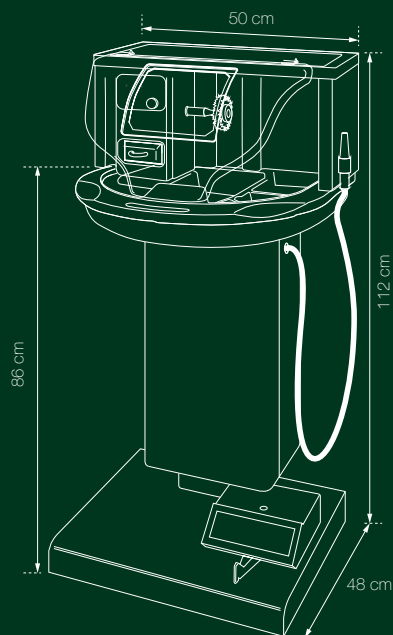

ZIL FOR S.R.L.

Via Fossa, 37 31051 FOLLINA (TV) - Italy

T. 0438/970308 F. 0438/971853 M. info@zilfor.com

[zilfor.com](http://zilfor.com)

## STANDARD EQUIPEMENTS / DOTAZIONI EQUIPEMENTS

1400 rpm single-shaft polisher

Noiseless suction unit

Lamp with high chromatic yield

Master switch and switches for singles appliances

Polycarbonate protection

Self-braking base to lay feet on

Housing for any make of rheostat and micromotor

Filter bag made from synthetic fibres

Pulitrice monoalbero a 1400 giri/minute

Aspirazione silenziosa

Lampada ad alta resa cromatica

Interruttore generale e Interruttori per l'accensione delle singole funzioni

Protezione in policarbonato

Base auto - frenante

Alloggiamento per qualsiasi marca di reostato e micromotore

Sacchetto filtro in fibre sintetiche

Polisseuse mono-arbre à 1400 tours/minute

Système d'aspiration silencieux

Lampe à haut rendement chromatique

Interrupteur général et interrupteurs pour allumer chaque appareil

Protection en polycarbonate

Base autofreinante pour l'appuis des pieds

Logement pour une marque quelconque de rhéostat et micromoteur

Filtre à sac en fibres synthétiques